

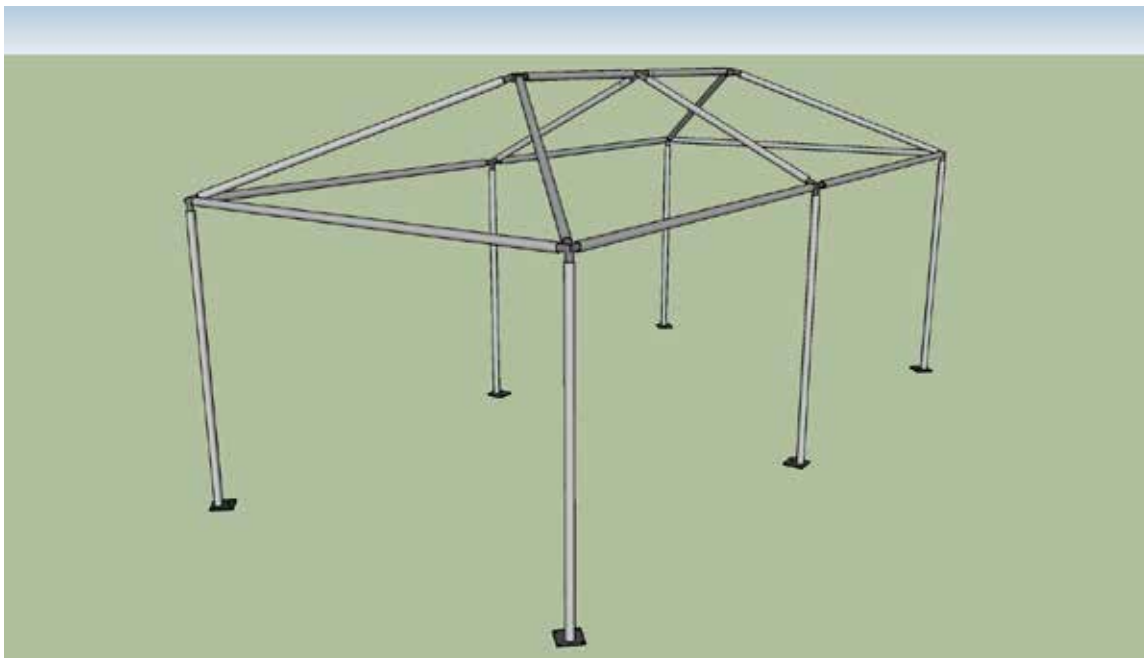

Ohenry 10'x 20' High Peak Frame Tent



Ohenry Productions Inc. 3859 Chappel Hill Rd. Waco, TX. 76705
(254)714-1103 Office (254)714-1117 Fax



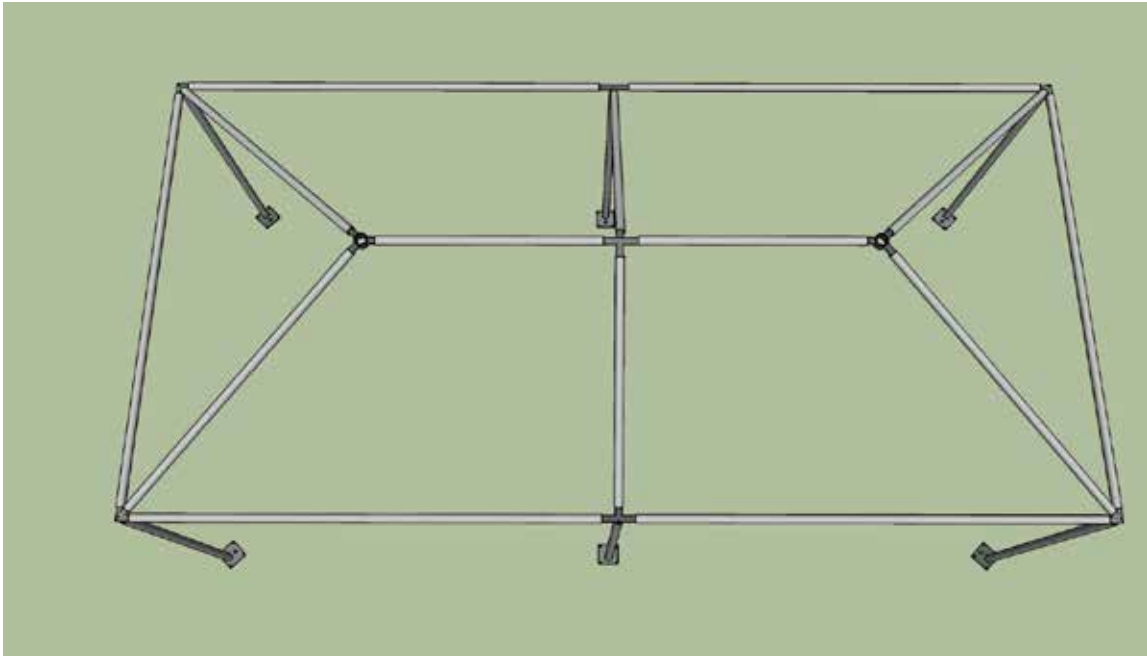

OHenry 10'x 20' Frame Tent

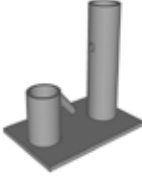

OHenry Productions Inc. 3859 Chappel Hill Rd. Waco, TX. 76705
(254)714-1103 Office (254)714-1117 Fax

Fittings	
4	Corner Fitting
2	3 Way HP Crown
2	Side T Joint
1	Ridge Top T
6	Premium Base Plates
38	Canopy Pins
6	24" Stakes
6	Guy Ropes
6	1" Ratchet Straps
2	High Peak Masts

Poles		
6	9' 4"	Speaders
2	4' 4"	Spreaders
4	6' 10"	Hip Rafters
2	4' 11"	Rafters
6	6' 8"	Legs

Part Identification	
 <p>3-Way High Peak End Crown</p>	 <p>Base Plate (premium)</p>
 <p>Corner Fitting</p>	 <p>Canopy Pin</p>
 <p>Center Mast</p>	 <p>1" Ratchet</p>

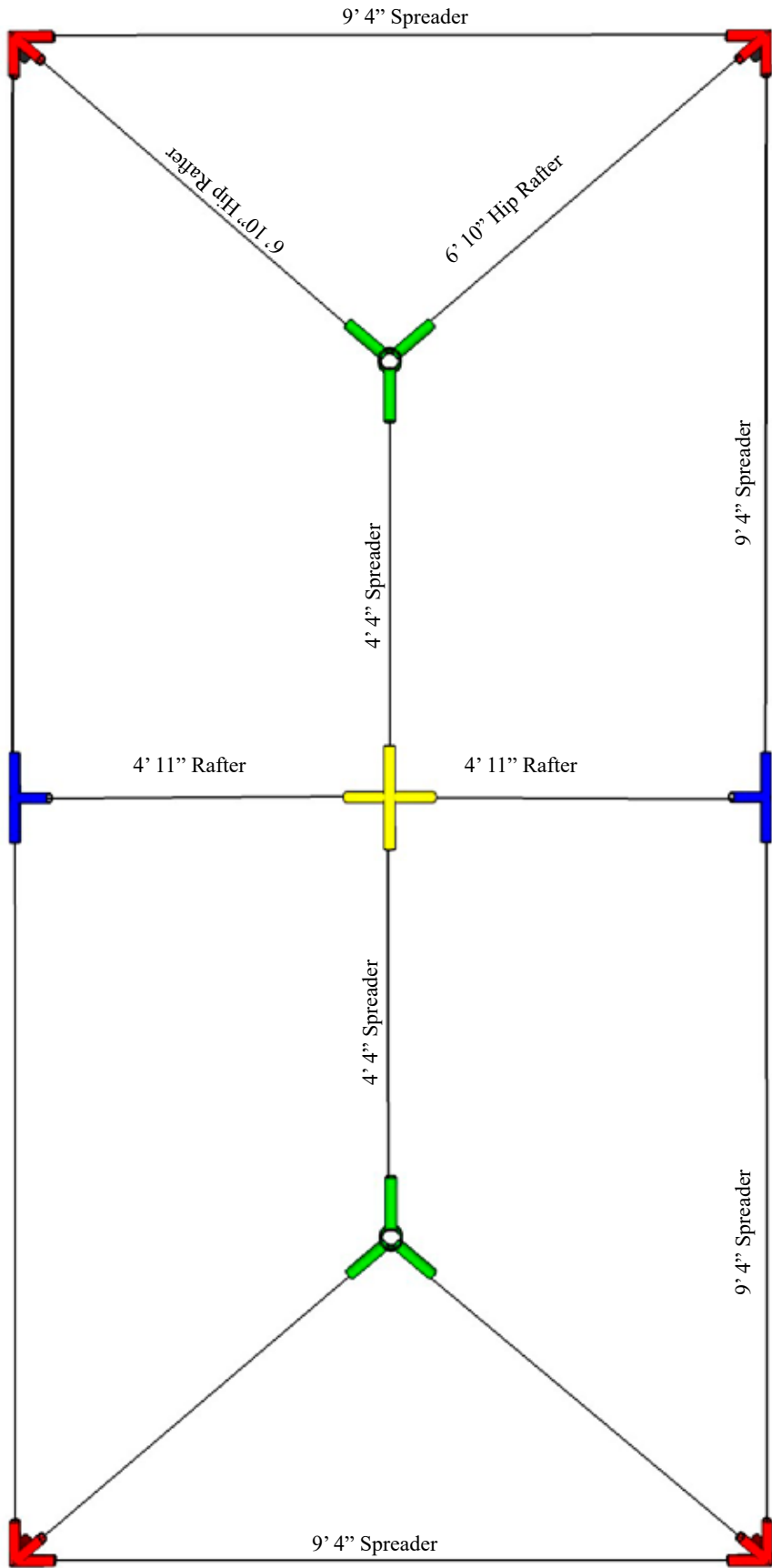

Ohenry Productions Inc. 3859 Chappel Hill Rd. Waco, TX. 76705
 (254)714-1103 Office (254)714-1117 Fax

“OHENRY WEST COAST FRAME TENT” ASSEMBLY INSTRUCTIONS
10' wide – 20' wide

All tubing is labeled for easy Identification.

Please verify the parts with the chart provided before you begin assembly.

Assembly Steps:

1. Lay out the Spreader pipes and Corner Fittings in a square or rectangle (refer to previous page). Lay out Hip Rafters and Rafters and Side T Joints. Place Center Crown(s) in the center of the tent.

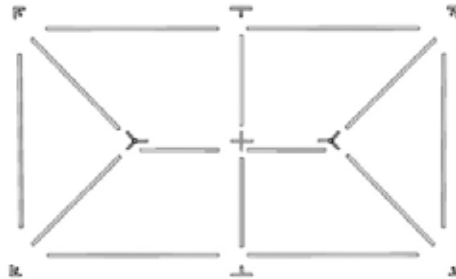

2. Start assembling the frame by inserting and pinning the Hip Rafters into the Center Crown(s). If assembling a rectangular frame insert and pin the appropriate Spreader into the Center Crown and continue to the next Ridge Top T or Center Crown. Insert and pin Rafters into the Crowns and Ridge Top T's. Insert and pin all Corner Fittings and Side T Joints to the bottom of the Hip Rafters and Rafters.



3. Start at one corner of the frame and insert and pin the Corner Fitting to the Spreader. Continue in one direction around the frame inserting and pinning each fitting to the Spreader.



4. Unfold the tent cover on the ground next to the assembled frame. Place the cover on the frame. Be sure to center the cover while the upper structure is still on the ground.



5. Lift one side of the tent and attach the legs (with base plates) and insert the pins. It is recommended that two people be available when lifting the frame to install legs.

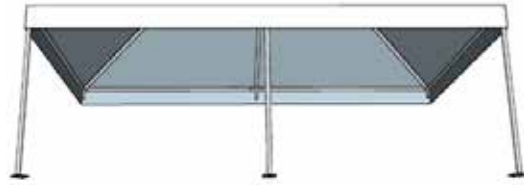

6) Push the square mast up through the one of the 3-way crowns from the bottom.

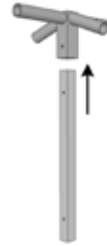

7) Push the removeable mast top into the hole in the center of the tent, then insert the top piece back into the mast and secure with a canopy pin



8) Push the mast up until the holes in the bottom of mast align with the holes in the bottom of the 3-way Crown.

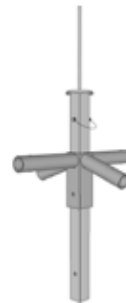

9) Secure mast to the 3-way crown with canopy pins. Repeat for second Mast.



10. Lift the other side of the tent and attach the legs (with base plates).

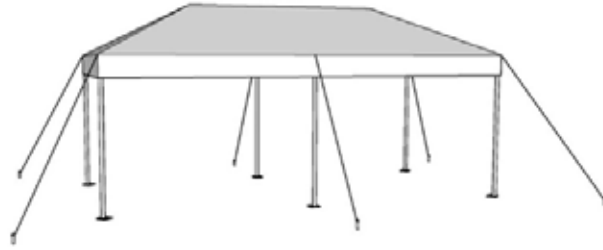

11) Next you will attach the end of the ratchet strap which has the metal clip (ratchets are included with your tent top) to the rings in the tent top at the corners and depending on size, the other locations on the tent top perimeter which have rings attached. Next attach the other end of each ratchet which has a ring attached to the base as shown in the photograph below. Tighten ratchet enough to have a slight tension. Do the same for each leg. Be sure tent is aligned correctly on the frame, and then retighten all the ratchets attached to the tent top and base plates as shown.

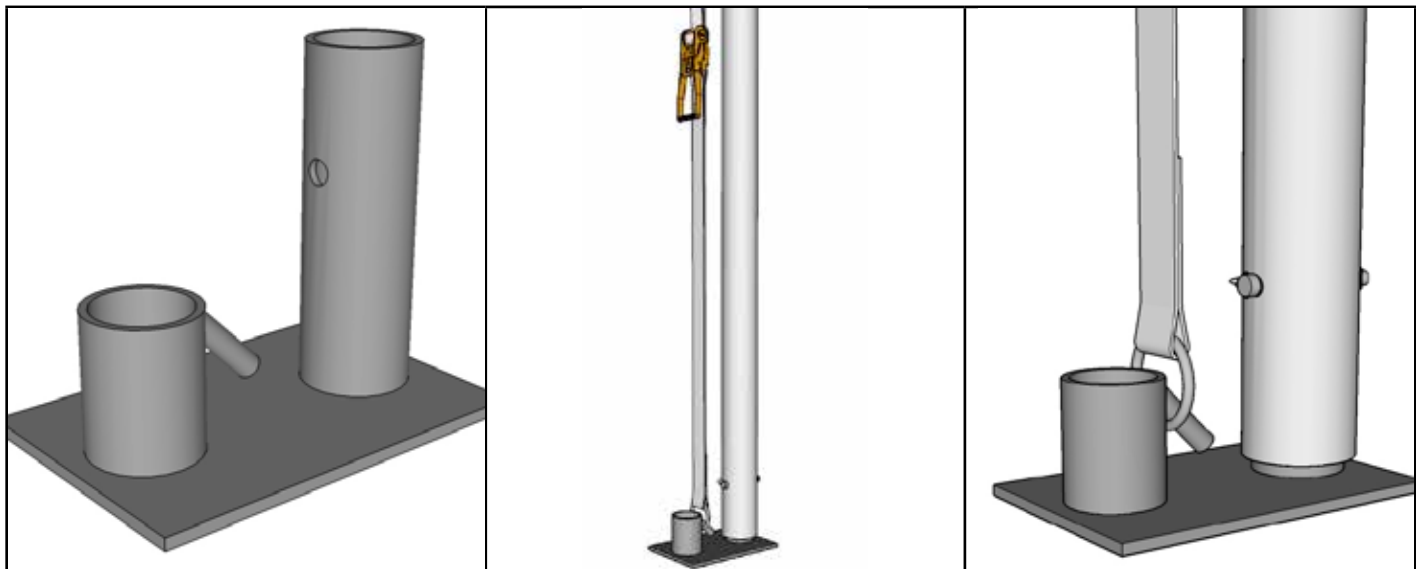

12) At each leg, now drive a tent stake into the ground about 5' from the edge of the tent. Attach the Guy Ropes provided with your tents and tighten securely to the tent stake. provided. **In the event of high winds, the cover should be removed from the frame to prevent damage to your tent. Your tent should be vacated during inclement weather.**